

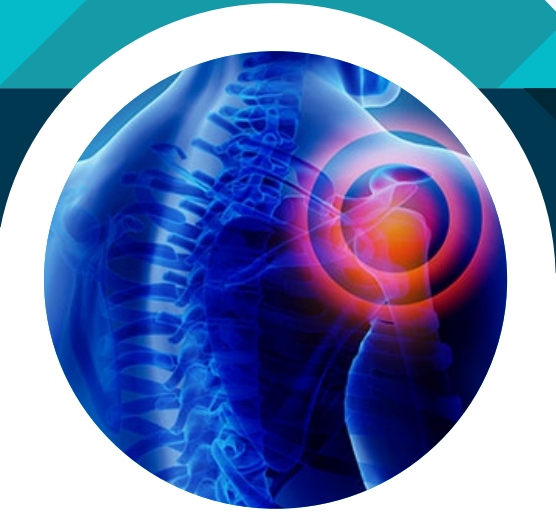

Arhman Surgical  
Benefiting you is our Priority



# ARHMAN SURGICAL

---

Our commitment to provide you products of your, requirements means you get exactly that.... 100% satisfaction.....guaranteed!.



Rehman Hussain



Arhmansurgical



Mobile & Whatsapp : +92-334-8046177



Arhman Surgical  
Benefiting you is our Priority

S.NO.	DESCRIPTION	P. NOS.
1	Drill Bits & Bone Taps	1 - 2
2	Basic Instruments	3 - 7
3	Instruments For Mini Fragment	8 - 9
4	Bone Drill & Wire Instruments	10 - 13
5	Bone Holding Instruments	14 - 16
6	Bone Cutting Instruments	17 - 19
7	Bone Hammers	20
8	Hooks, Levers & Retractors	21 - 25
9	Periosteal Elevator	26
10	Instruments For Kuntscher Nails	27 - 28
11	Instruments For Hip Prosthesis	29 - 30
12	Instruments For Plaster Cutting	31
13	Instruments For Anchor Screw / Instruments For Skull Surgery & Cannulated Rigid Reamer	32
14	Instruments For Interlocking Nail Removal	33
15	Hand Drills	34
16	Bone Curettes	35
17	Wire Twisting Forceps	36



ISO 9001: 2016  
ISO 13485: 2016



info@arhmansurgicals.com



Mobile & Whatsapp : +92-334-8046177



Arhman Surgical  
Benefiting you is our Priority

S.NO.	DESCRIPTION	P. NOS.
21	Flat Nose Plier	37 - 38
22	Strinmenn Tendon Holding Forceps	39
23	Bone Holding Forceps	40
24	Aluminum Hands	41
25	Nail Fixation Orthopedic	42
26	Tibia Plates	43 - 44



ISO 9001: 2016  
ISO 13485: 2016



info@arhmansurgicals.com



Mobile & Whatsapp : +92-334-8046177



Arhman Surgical  
Benefiting you is our Priority

## Drill Bit - S.S. - Titanium Coated, Quick Coupling End & Plain Shank

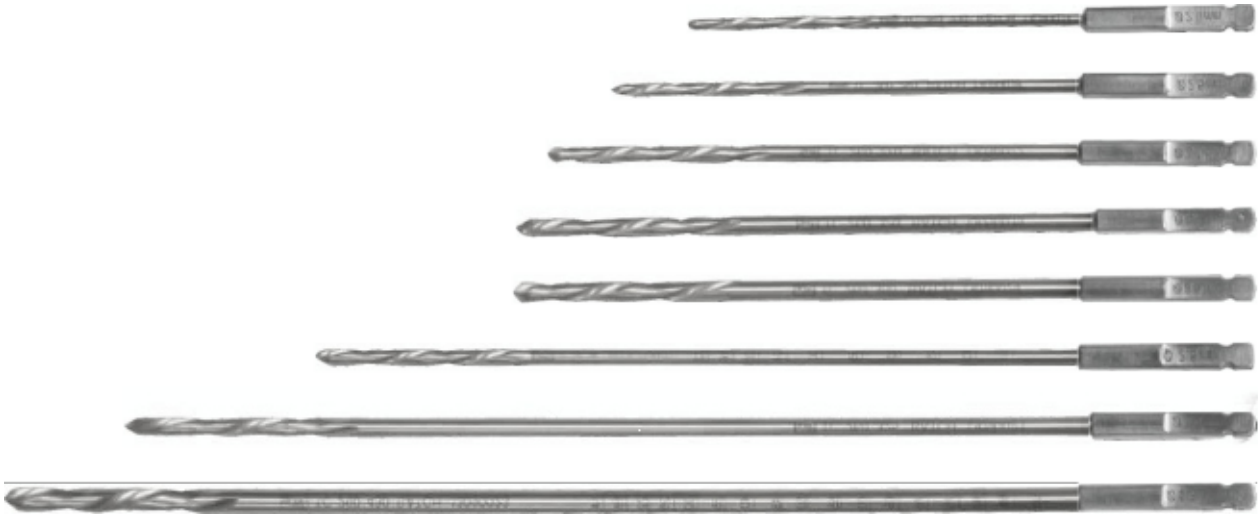

### Cat No. Drill Bit - S.S. - Titanium Coated, Quick Coupling End & Plain Shank

AR0-TC-120	Size : 2.0mm Dia. X 100mm Long, Quick Coupling End
AR0-TC-125	Size : 2.0mm Dia. X 140mm Long, Quick Coupling End
AR0-TC-130	Size : 2.5mm Dia. X 115mm Long, Quick Coupling End
AR0-TC-135	Size : 2.7mm Dia. X 125mm Long, Quick Coupling End
AR0-TC-140	Size : 2.8mm Dia. X 165mm Long, Calibrated, Quick Coupling End
AR0-TC-145	Size : 3.2mm Dia. X 130mm Long, Quick Coupling End
AR0-TC-150	Size : 3.2mm Dia. X 200mm Long, Quick Coupling End
AR0-TC-155	Size : 3.5mm X 130mm Long, Quick Coupling End
AR0-TC-160	Size : 4.3mm Dia. X 221mm Long, Calibrated, Quick Coupling End

### Cat No. Cannulated Drill Bits - Titanium Coated

AR0-TC-165	Size : 2.5mm Dia. X 75mm Long, Plain Shank	( For Guide Wire 0.9 MM )
AR0-TC-170	Size : 2.7mm Dia. X 130mm Long, Quick Coupling End	( For Guide Wire 1.25 MM )
AR0-TC-175	Size : 3.5mm Dia. X 130mm Long, Quick Coupling End	( For Guide Wire 1.25 MM )
AR0-TC-180	Size : 4.5mm Dia. X 230mm Long, Plain Shank	( For Guide Wire 2.0 MM )





## Drill Bits & Bone Taps

### Drill Bit - S.S. Quick Coupling End



Cat No.	Dia	Length
AR1-110	1.1mm	60mm
AR1-115	1.5mm	60mm
AR1-120	1.5mm	85mm
AR1-125	1.5mm	95mm
AR1-130	2.0mm	100mm
AR1-135	2.0mm	125mm
AR1-140	2.5mm	115mm
AR1-142	2.5mm	180mm
AR1-143	2.5mm	200mm
AR1-144	2.7mm	125mm
AR1-145	2.7mm	200mm
AR1-146	2.8mm	Calibrated 165mm
AR1-147	3.2mm	130mm
AR1-148	3.2mm	200mm
AR1-149	3.2mm	145mm
AR1-151	3.5mm	110mm
AR1-152	3.5mm	130mm
AR1-153	3.5mm	200mm
AR1-154	4.3mm	Calibrated 221mm
AR1-155	4.5mm	130mm
AR1-156	4.5mm	145mm
AR1-157	4.5mm	200mm
AR1-158	Dia. 4.5mm x 4.0mm x 310mm	

### Bone Tap With T - Handle

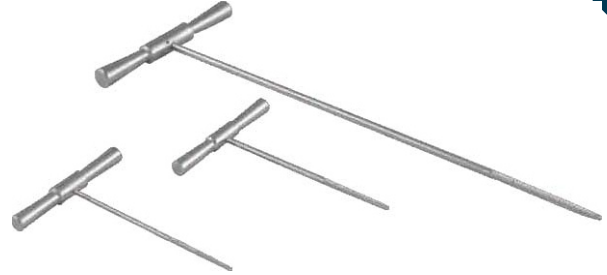

Cat No.	Dia	Thread Length	Total Length
AR2-110	1.5mm	24mm	75mm
AR2-115	2.0mm	24mm	75mm
AR2-120	2.7mm	33mm	125mm
AR2-125	2.7mm	33mm	200mm
AR2-130	3.5mm	50mm	125mm
AR2-135	3.5mm	50mm	200mm
AR2-140	4.0mm	50mm	125mm
	Cancellous		
AR2-142	4.5mm	70mm	125mm
AR2-143	4.5mm	70mm	175mm
AR2-144	6.5mm	32mm	200mm
	Cancellous		

### Drill Bit - Plain Shank / Jacob Chuck End

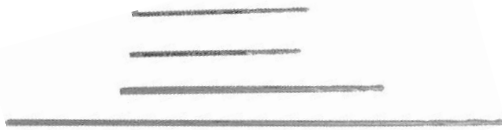

S.S. Cat No.	Dia	Length	H.S.S. Cat No.
AR1-159	1.1mm	60mm	-
AR1-160	1.5mm	60mm	-
AR1-161	2.0mm	100mm	-
AR1-162	2.0mm	200mm	-
AR1-163	2.5mm	115mm	262.005
AR1-164	2.5mm	200mm	-
AR1-165	2.7mm	130mm	262.010
AR1-166	2.7mm	200mm	-
AR1-168	3.2mm	130mm	262.015
AR1-169	3.2mm	200mm	262.020
AR1-170	3.5mm	130mm	262.025
AR1-172	3.5mm	200mm	262.030
AR1-173	4.5mm	130mm	262.035
AR1-174	4.5mm	200mm	262.040

### Bone Tap Quick Coupling END



Cat No.	Dia	Thread Length	Total Length
AR2-145	1.5mm	24mm	50mm
AR2-146	2.0mm	24mm	75mm
AR2-147	2.7mm	33mm	100mm
AR2-148	3.5mm	50mm	110mm
AR2-149	3.5mm	50mm	175mm
AR2-150	4.0mm	85mm	110mm
	Cancellous		
AR2-151	4.5mm	70mm	125mm
AR2-152	4.5mm	70mm	175mm
AR2-153	6.5mm	32mm	195mm
	cancellous		
AR2-154	5.5mm	100mm	195mm





**Arhman Surgical**  
Benefiting you is our Priority

Hexagonal Screw Driver with Self Holding Sleeve

Hexagonal Screw Driver with Sleeve 2.5mmTip  
**AR3-110**

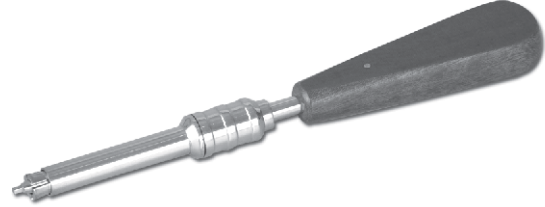
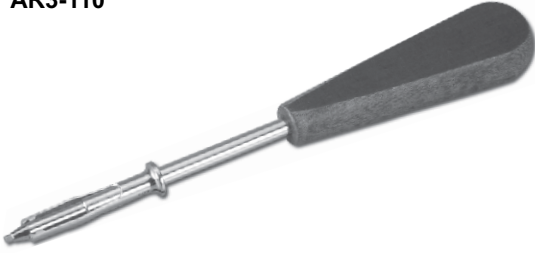

Cat. No.	Size
<b>AR3-115</b>	For 2.5mm Tip
<b>AR3-116</b>	For 3.5mm Tip

Small Hexagonal Screw Driver

Screw Driver Shaft, Q. C. End - 2.5mmTip  
**AR3-117**

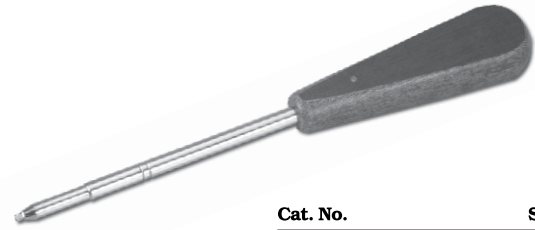

Cat. No.	Size
<b>AR3-118</b>	For 2.5mm Tip
<b>AR3-119</b>	For 3.5mm Tip



Screw Driver Shaft, Q. C. End - 3.5mmTip  
**AR3-120**

Small Plate Bender (Pair)  
**AR3-121**

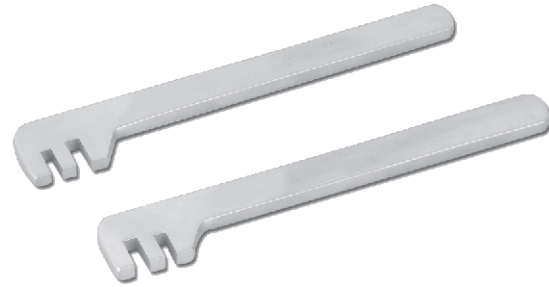

Large Plate Bender (Pair)  
**AR3-122**

Plate Bending Plier (Roller Type)  
**AR3-123**





**Arhman Surgical**  
Benefiting you is our Priority

**Basic Instruments**

Plate Bender for Reconstruction Plates



Cat. No.	Size
<b>AR4-116</b>	For 2.7mm Plates
<b>AR4-117</b>	For 3.5mm Plates
<b>AR4-118</b>	For 4.5mm Plates

Plate Bending Press

**AR4-115**



Depth Gauge



Cat. No.	Size
<b>AR4-120</b>	Small
<b>AR4-121</b>	Large

Small Neutral & Loaded Drill Guide

**AR4-119**



Large Neutral & Loaded Drill Guide

**AR4-122**



DCP Drill Guide for 2.7mm Screws (2.0mm Drill Bit)

**AR4-123**



Counter Sink with T-Handle - 5.0mm Head  
(for 1.5 & 2.0mm Screws)

**AR4-124**

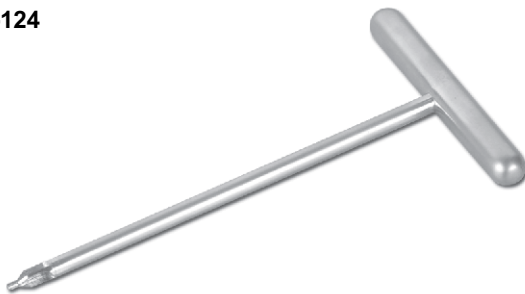

Counter Sink with T-Handle - 6.0mm Head  
(for 2.7, 3.5 & 4.0mm Screws)

**AR4-125**

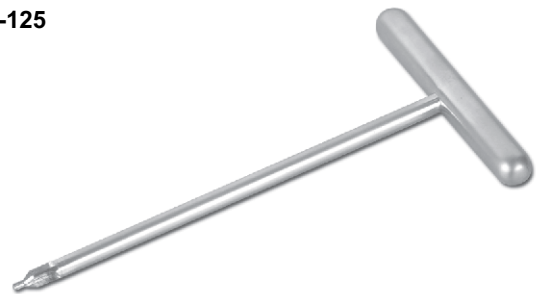

info@arhmansurgicals.com



Mobile & Whatsapp : +92-334-8046177



**Arhman Surgical**  
Benefiting you is our Priority

### Basic Instruments

Counter Sink with T-Handle - 8.0mm Head  
(for 4.5, & 6.5mm Screws)  
**AR4-130**



Counter Sink - Q. C. End - 5.0mm (for 1.5 & 2.0mm Screws)  
**AR4-133**



Counter Sink - Q. C. End - 6.0mm Head  
(for 2.7, 3.5 & 4.0mm Screws)  
**AR4-131**



Counter Sink - Q. C. End - 8.0mm Head  
(for 4.5 & 6.5mm screws)  
**AR4-132**



Quick Coupling Handle T - Type  
**AR4-134**

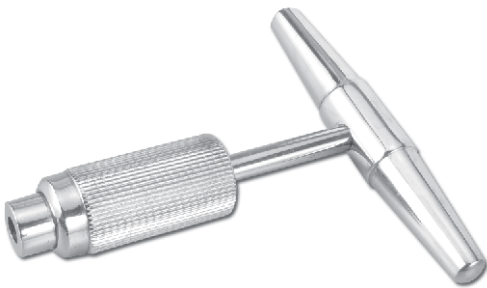

Quick Coupling Handle (Fibre Handle)  
**AR4-135**

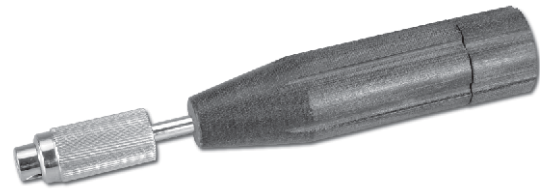

Quick Coupling Adaptor for Drill Bits  
**AR4-137**

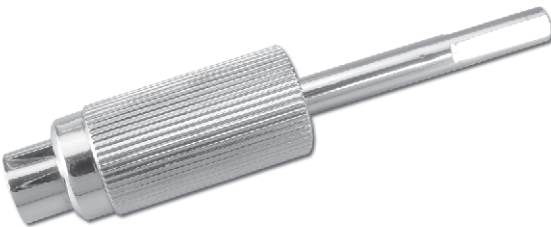

Quick Coupling Tap Handle - Long , T - Type  
**AR4-136**







**Arhman Surgical**  
Benefiting you is our Priority

## Basic Instruments

Tap Sleeve - 3.5mm  
**AR4-137**



Tap Sleeve - 4.5mm  
**AR4-138**



Double Drill Sleeve - 1.5/1.1mm  
**AR4-140**



Double Drill Sleeve - 2.0/1.5mm  
**AR4-139**



Double Drill Sleeve - 2.7/2.0mm  
**AR4-141**



Drill & Tap Sleeve Combined - 2.5/3.5mm  
**AR4-142**



Drill & Tap Sleeve Combined-3.2/4.5mm  
**AR4-143**



Drill & Tap Sleeve Combined-3.2/6.5mm  
**AR4-144**



[info@arhmansurgicals.com](mailto:info@arhmansurgicals.com)



Mobile & Whatsapp : +92-334-8046177



**Arhman Surgical**  
Benefiting you is our Priority

### Basic Instruments

Insert Drill Sleeve 2.5mm  
**AR4-145**



Insert Drill Sleeve 3.2mm  
**AR4-146**



Pointed Drill Guide with 4.5mm Tap Sleeve & 3.2mm Insert Drill Sleeve  
**AR4-147**



Screw Holding Forceps  
**AR4-148**



Screw Removal Forceps  
**AR4-149**



Screw Removal Forceps with Ratchet Lock  
**AR4-150**

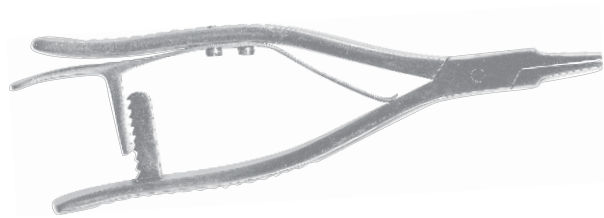

Hollow Mill



Bending Plier for Reconstruction Plates, 3.5mm & 4.5mm  
**AR4-151**

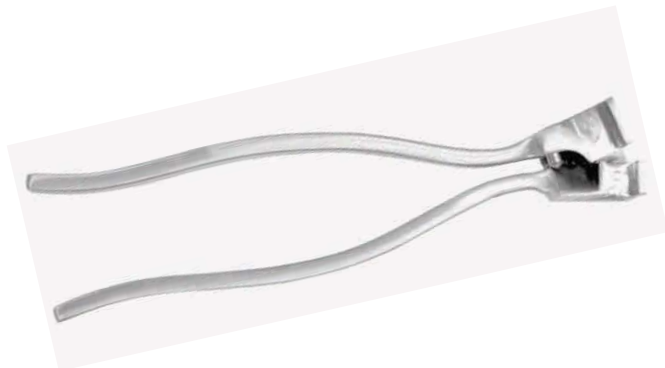

Cat. No.	Size
<b>AR4-152</b>	Small - For Removal of Drill Bits
<b>AR4-153</b>	Medium -For Removal of 3.5mm Screws
<b>AR4-154</b>	Large-For Removal of 4.5 & 6.5mm Screws





**Arhman Surgical**  
Benefiting you is our Priority

## Instruments For Mini Fragment

Hexagonal Screw Driver with Sleeve (1.5mm)



Cat. No.	Length
AR4-156	125 mm
AR4-157	165 mm

Mini Depth Gauge  
**AR4-155**



Mini Self Retaining Retractor for Fingers  
**AR4-158**



Mini Self Retaining Retractor for Metacarpals  
**AR4-159**



Mini Self Retaining Retractor for Metacarpals with Hinge  
**AR4-160**

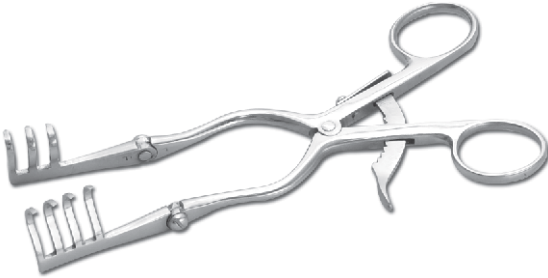

Mini Neutral & Loaded Drill Guide - for 1.5mm Drill Bit  
**AR4-161**

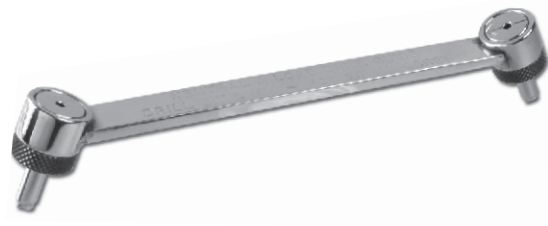

Mini Plate Bender (Pair)  
**AR4-162**



Mini Plate Holding Forceps  
**AR4-163**





**Arhman Surgical**  
Benefiting you is our Priority

## Instruments For Mini Fragment

Mini Plate & Bone Holding Forceps  
**AR4-164**



Mini Reduction Forceps Serrated  
**AR4-165**



Mini Reduction Forceps Pointed  
**AR4-166**



Mini Periosteal Elevator  
**AR4-167**



Mini Chisels

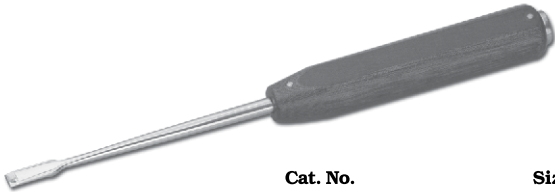

Cat. No.	Size
AR4-168	4 mm
AR4-169	6 mm
AR4-170	8 mm
AR4-171	10 mm
AR4-172	12 mm

Mini Osteotomes



Cat. No.	Size
AR4-173	4 mm
AR4-174	6 mm
AR4-175	8 mm
AR4-176	10 mm
AR4-177	12 mm

Mini Gouge



Cat. No.	Size
AR4-178	4 mm
AR4-179	6 mm
AR4-180	8 mm
AR4-181	10 mm
AR4-182	12 mm

Mini Hohmann Retractor



Cat. No.	Size
AR4-183	6 mm
AR4-184	8 mm
AR4-185	10 mm





**Arhman Surgical**  
Benefiting you is our Priority

## Bone Drill & Wire Instruments

RALK Bone Hand Drills

**AR4-187**



Wire Tightner with Two Pegs  
**AR4-188**

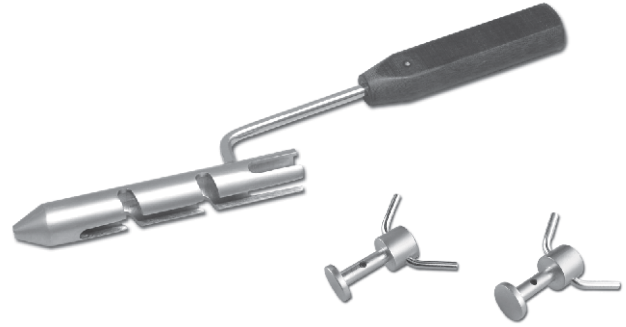

Wire Tightner Cum Twister  
**AR4-189**



Guide Wire Introducer with Four Pegs  
**AR4-190**

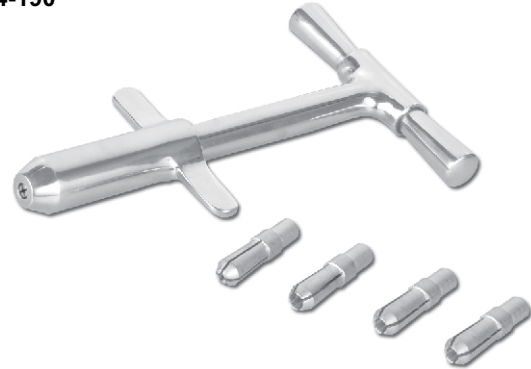

Circlage Passer  
**AR4-191**

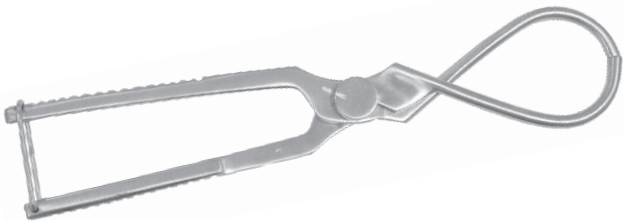

Circular Wire Cutter (Capacity up to 3.0mm)  
**AR4-192**

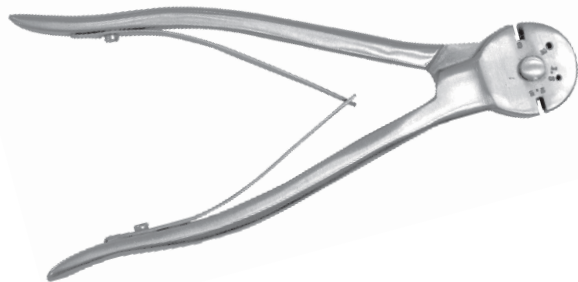

info@arhmansurgicals.com



Mobile & Whatsapp : +92-334-8046177



Arhman Surgical  
Benefiting you is our Priority

## Bone Drill & Wire Instruments

K. Wire Bender  
**AR4-193**



Wire Passer - Small  
**AR4-194**



Wire Passer - Medium  
**AR4-195**



Wire Passer - Large  
**AR4-196**



Plier Cum Wire Bender  
**AR4-197**



Plier Cum Wire Bender Cum Wire Cutter - 6"  
**AR4-198**



Plier Cum Wire Bender Cum Wire Cutter - 9"  
**AR4-199**



Plier Cum Wire Bender Cum Wire Cutter - 11"  
**AR4-200**





**Arhman Surgical**  
Benefiting you is our Priority

## Bone Drill & Wire Instruments

Wire Cutter - Double Action, Length - 250mm

**AR5-201**



Large Pin Cutter Capacity 3.0 mm to 6.0 mm

**AR5-202**

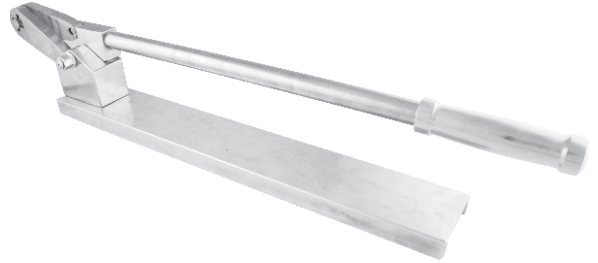

Flat Nose Plier

**AR5-203**



Steinmann Pin Introducer with S. S. Chuck & Key

**AR5-204**

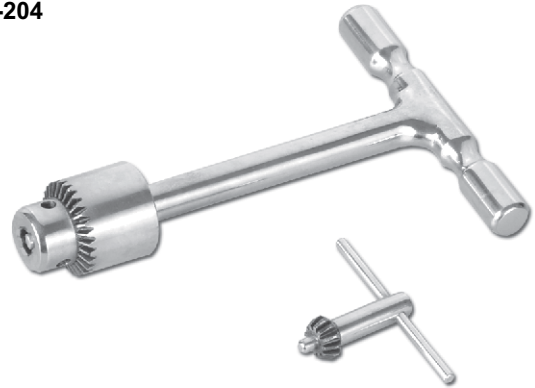

Spare S. S. Chuck & Key

**AR5-205**

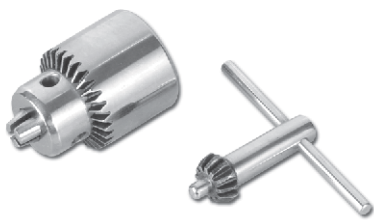

Spare key for Drill Machine

**AR5-206**



Spare Chuck for Drill Machine

**AR5-207**



Spare Key for T - Handle

**AR5-208**





**Arhman Surgical**  
Benefiting you is our Priority

## Bone Drill & Wire Instruments

Spare Chuck & Key Imported Steel (6.0mm Capacity)

**AR5-209**



Steinman Pin Holder

Steinmann Pin Introducer with Imported stainless Steel Chuck & Key (6.0mm Capacity)

**AR5-210**



Steinmann Pin Holder



Cat. No.		Size
<b>AR5-211</b>	Small	8"
<b>AR5-212</b>	Medium	10"
<b>AR5-213</b>	Large	12"

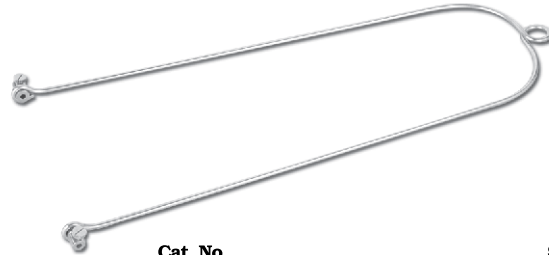

Cat. No.		Size
<b>AR5-214</b>	Extra Large	14"
<b>AR5-215</b>	Extra Large	16"
<b>AR5-216</b>	Extra Large	18"
<b>AR5-217</b>	Extra Large	20"

Bone Awl with Eye



Cat. No.		Dia
<b>AR5-219</b>		2.0mm
<b>AR5-220</b>		2.5mm
<b>AR5-221</b>		3.0mm

Reamer - Perthes, 18.5cm

**AR5-218**

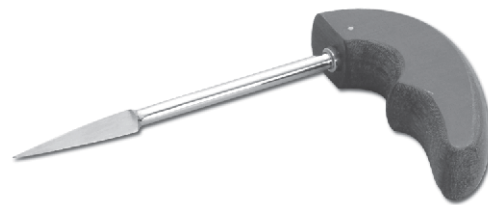

Tripple Drill Guide



Cat. No.		Dia
<b>AR5-222</b>	For 2.0mm Wires	
<b>AR5-223</b>	For 2.5mm Wires	



info@arhmansurgicals.com



Mobile & Whatsapp : +92-334-8046177





# Arhman Surgical

Benefiting you is our Priority

## Self Centering Bone Holding Forceps



Cat. No.	Length
AR5-224	150 mm
AR5-225	190 mm
AR5-226	240 mm
AR5-227	260 mm
AR5-228	280 mm

## Reduction Forceps - Serrated - Ratchet Lock



Cat. No.	Length
AR5-229	140 mm
AR5-230	170 mm

## Reduction Forceps - Serrated - Speed Lock



Cat. No.	Length
AR5-231	170 mm
AR5-232	200 mm
AR5-233	240 mm

## Reduction Forceps - Pointed - Ratchet Lock



Cat. No.	Length
AR5-223	140 mm
AR5-223	170 mm
AR5-223	200 mm

## Reduction Forceps - Pointed - Speed Lock



Cat. No.	Length
AR5-235	170 mm
AR5-236	200 mm
AR5-237	240 mm

## Patella Bone Holding Forceps - Three Prong AR5-234



## Patella Bone Holding Forceps - Four Prong AR5-238





**Arhman Surgical**  
Benefiting you is our Priority

## Bone Holding Instruments

Pelvic Reduction Forceps, Oblique, Small  
Length - 190mm, with Pointed Ball Tips, Speed Lock  
**AR5-239**



Pelvic Reduction Forceps, Oblique, Small  
Length - 240mm, with Pointed Ball Tips, Speed Lock  
**AR5-240**



Pelvic Reduction Forceps  
Length - 400mm, with Pointed Ball Tips, Speed Lock  
**AR5-241**



Pelvic Reduction Forceps, Small, For Screws  
Length - 200mm, use with 3.5 and 4.5mm Cortical Screws  
**AR5-242**



Pelvic Reduction Forceps, Medium, Length - 250mm,  
use with 3.5 and 4.5mm Cortical Screws  
**AR5-243**



Pelvic Reduction Forceps, Large, Length - 330mm,  
Speed Lock, Fixation with 4.5mm Cortical Screws  
**AR5-244**



Pelvic Reduction Forceps, with Angled Pointed  
Ball Tips, Length - 250mm, Speed Lock  
**AR5-245**



Pelvic Reduction Forceps, Long, with Pointed Ball Tips, Length  
- 400mm, Speed Lock  
**AR5-246**

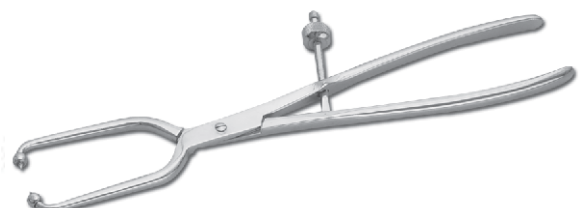

info@arhmansurgicals.com



Mobile & Whatsapp : +92-334-8046177



**Arhman Surgical**  
Benefiting you is our Priority

## Bone Holding Instruments

Pelvic Reduction Forceps, Long, with Three Pointed Ball Tips, Length - 400mm, Speed Lock

**AR5-247**



Lane Bone Holding Forceps with Ratchet



Cat. No.	Size
<b>AR5-248</b>	200mm
<b>AR5-249</b>	250mm
<b>AR5-250</b>	300mm

Lane Bone Holding Forceps without Ratchet



Cat. No.	Size
<b>AR5-251</b>	200mm
<b>AR5-252</b>	250mm
<b>AR5-253</b>	300mm

Burn's Bone Holding Forceps

**AR5-254**



Periarticular Reduction Forceps, Small - Jaw Opening 95mm

**AR5-255**

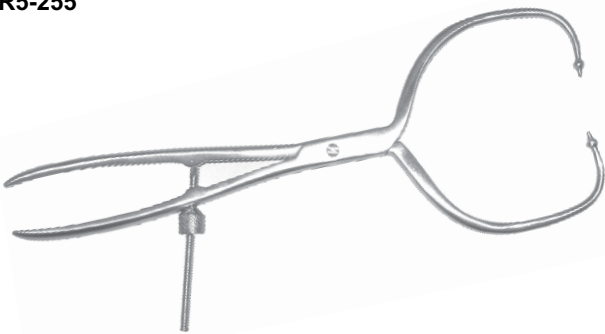

Periarticular Reduction Forcep

**AR5-256**



Periarticular Reduction Forceps, Large - Jaw Opening 145mm

**AR5-257**

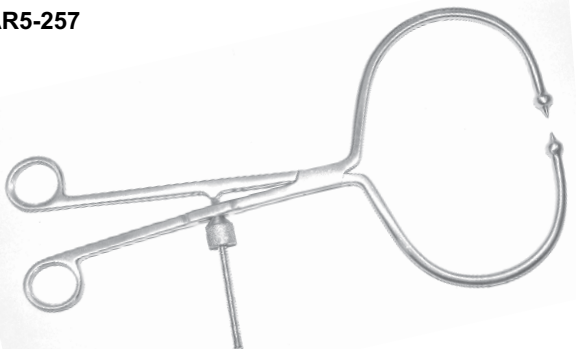

info@arhmansurgicals.com



Mobile & Whatsapp : +92-334-8046177



**Arhman Surgical**  
Benefiting you is our Priority

## Bone Cutting Instruments

Bone Cutting Forceps - Straight (Double Action)

Cat. No.	Size
<b>AR5-258</b>	190mm
<b>AR5-259</b>	225mm
<b>AR5-260</b>	270mm

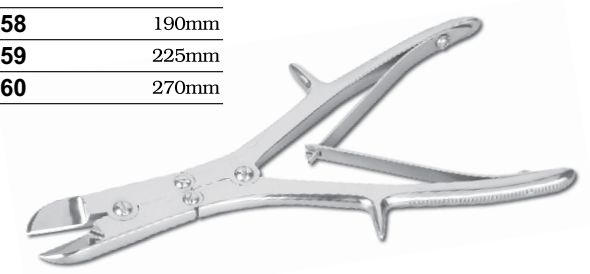

Bone Cutting Forceps - Curved (Double Action)

Cat. No.	Size
<b>AR5-261</b>	190mm
<b>AR5-262</b>	225mm
<b>AR5-263</b>	270mm

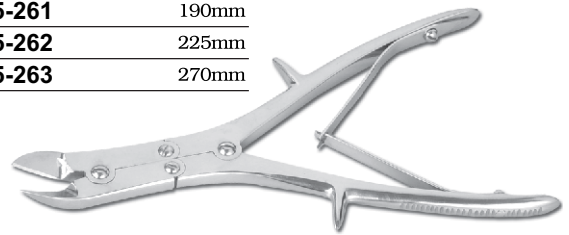

Bone Nibbler - Straight (Double Action)



Cat. No.	Size
<b>AR5-264</b>	190mm
<b>AR5-265</b>	225mm
<b>AR5-266</b>	270mm

Bone Nibbler - Curved (Double Action)



Cat. No.	Size
<b>AR5-267</b>	190mm
<b>AR5-268</b>	225mm
<b>AR5-269</b>	270mm

Bone Nibbler - Angular (Double Action)

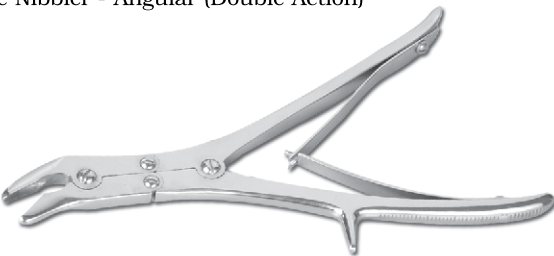

Cat. No.	Size
<b>AR5-270</b>	190mm
<b>AR5-271</b>	225mm
<b>AR5-272</b>	270mm

Tuder Edward Bone Cutting Forceps  
**AR5-273**





**Arhman Surgical**  
Benefiting you is our Priority

## Bone Cutting Instruments

Amputation Saw  
**AR5-274**



Finger Saw  
**AR5-275**



Bone File - Half Round - Pointed  
**AR5-276**



Bone File - Flat  
**AR5-277**



Cat. No.	Size
<b>AR5-273</b>	100mm
<b>AR5-273</b>	150mm

Chisels with Fibre Handle



Cat. No.	Size
<b>AR5-278</b>	5mm
<b>AR5-279</b>	10mm
<b>AR5-280</b>	15mm
<b>AR5-281</b>	20mm
<b>AR5-282</b>	25mm
<b>AR5-283</b>	30mm

Osteotome with Fibre Handle - Straight



Cat. No.	Size	Cat. No.	Size
<b>AR5-284</b>	5mm	<b>AR5-290</b>	16mm
<b>AR5-285</b>	8mm	<b>AR5-291</b>	18mm
<b>AR5-286</b>	10mm	<b>AR5-292</b>	20mm
<b>AR5-287</b>	12mm	<b>AR5-293</b>	25mm
<b>AR5-288</b>	14mm	<b>AR5-294</b>	30mm
<b>AR5-289</b>	15mm		

Osteotome with Fibre Handle - Curved



Cat. No.	Size	Cat. No.	Size
<b>AR5-295</b>	5mm	<b>AR5-300</b>	16mm
<b>AR5-296</b>	8mm	<b>AR5-301</b>	18mm
<b>AR5-297</b>	10mm	<b>AR5-302</b>	20mm
<b>AR5-298</b>	12mm	<b>AR5-303</b>	25mm
<b>AR5-299</b>	14mm	<b>AR5-304</b>	30mm

Gouge with Fibre Handle - Straight



Cat. No.	Size	Cat. No.	Size
<b>AR5-305</b>	5mm	<b>AR5-310</b>	16mm
<b>AR5-306</b>	8mm	<b>AR5-311</b>	18mm
<b>AR5-307</b>	10mm	<b>AR5-312</b>	20mm
<b>AR5-308</b>	12mm	<b>AR5-313</b>	25mm
<b>AR5-309</b>	14mm	<b>AR5-314</b>	30mm



info@arhmansurgical.com



Mobile & Whatsapp : +92-334-8046177



**Arhman Surgical**  
Benefiting you is our Priority

## Bone Cutting Instruments

Gouge with Fibre Handle - Curved



Cat. No.	Size	Cat. No.	Size
<b>AR5-315</b>	5mm	<b>AR5-320</b>	16mm
<b>AR5-316</b>	8mm	<b>AR5-321</b>	18mm
<b>AR5-317</b>	10mm	<b>AR5-322</b>	20mm
<b>AR5-318</b>	12mm	<b>AR5-323</b>	25mm
<b>AR5-319</b>	14mm	<b>AR5-324</b>	30mm

Bone Curette - Double Ended



Cat. No.	Size
<b>AR5-325</b>	4mm x 6mm
<b>AR5-326</b>	6mm x 9mm
<b>AR5-327</b>	9mm x 12mm

Brun's Bone Curette with Fibre Handle



Cat. No.	Size	Cat. No.	Size
<b>AR5-328</b>	3mm	<b>AR5-332</b>	8mm
<b>AR5-329</b>	4mm	<b>AR5-333</b>	10mm
<b>AR5-330</b>	5mm	<b>AR5-334</b>	12mm
<b>AR5-331</b>	6mm		



Veterinary cerclage wire passer 30mm

### Sterilizing Tubes

For Sterilization of Wires, Nails, Pins & Drill Bits

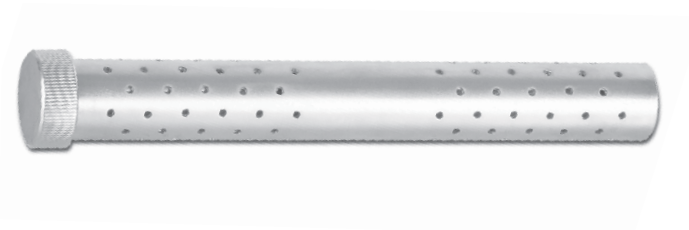

Cat. No.	Size
<b>AR5-335</b>	150mm
<b>AR5-336</b>	225mm
<b>AR5-337</b>	300mm
<b>AR5-338</b>	400mm
<b>AR5-339</b>	500mm



info@arhmansurgicals.com



Mobile & Whatsapp : +92-334-8046177



**Arhman Surgical**  
Benefiting you is our Priority

## Bone Hammers

Bone Hammer - 100gms.  
**AR6-400**



**AR6-401**  
Bone Hammer 26cm,  
610gms



Bone Hammer - 350gms.  
**AR6-402**

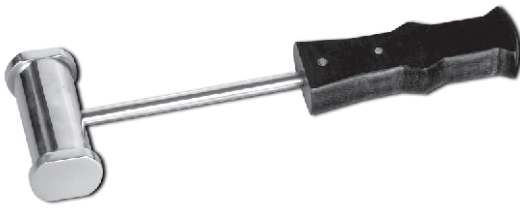

Bone Hammer - 500gms.  
**AR6-403**



Bone Hammer - 700gms.  
**AR6-404**



Bone Hammer - Nylon Faced  
**AR6-405**





**Arhman Surgical**  
Benefiting you is our Priority

## Hooks, Levers & Retractors

Bone Hook - Small  
**AR6-406**



Bone Hook - Medium  
**AR6-407**



Bone Hook - Large  
**AR6-408**



Skin Hook - Single Pronged  
**AR6-409**



Skin Hook - Two Pronged  
**AR6-410**



Skin Hook - Three Pronged  
**AR6-411**



Sharp Hook  
**AR6-412**



Lane's Bone Lever - Serrated  
**AR6-413**







**Arhman Surgical**  
Benefiting you is our Priority

## Hooks, Levers & Retractors

Lane's Bone Lever - Plain - Small  
**AR6-414**



Lane's Bone Lever - Plain - Large  
**AR6-415**



Bristow's Retractor  
**AR6-416**



Lagenback Retractor - Small  
**AR6-417**



Lagenback Retractor - Medium  
**AR6-418**



Lagenback Retractor - Large  
**AR6-419**



Volkman's Retractor - Two Prong  
**AR6-420**



Volkman's Retractor - Three Prong  
**AR6-421**





**Arhman Surgical**  
Benefiting you is our Priority

## Hooks, Levers & Retractors

Volkman's Retractor - Four Prong

**AR6-422**



Volkman's Retractor - Five Prong

**AR6-423**



Right Angle Retractor  
**AR6-424**



Double Hook Retractor  
**AR6-425**



Hohmann Retractor  
6mm Wide, Short Narrow Point, 160mm Length  
**AR6-426**



Hohmann Retractor  
8mm Wide, Short Narrow Point, 160mm Length  
**AR6-427**



Hohmann Retractor, 15mm Wide, 160mm Length  
**AR6-428**



Hohmann Retractor  
8mm Wide, Short Narrow Tip, 220mm Length  
**AR6-429**





**Arhman Surgical**  
Benefiting you is our Priority

### Hooks, Levers & Retractors

Hohmann Retractor  
18mm Wide, Short Narrow Tip, 235mm Length  
**AR6-430**



Hohmann Retractor  
18mm Wide, Long Narrow Tip, 235mm Length  
**AR6-431**



Hohmann Retractor  
22mm Wide, with Wide Tip, 250mm Length  
**AR6-432**



Hohmann Retractor  
24mm Wide, with Long Wide Tip, 270mm Length  
**AR6-432**



Hohmann Retractor  
43mm Wide, Narrow Tip, 240mm Length  
**AR6-434**



Hohmann Retractor  
70mm Wide, Narrow Tip, 240mm Length  
**AR6-435**



Self Retaining Retractor - Small - 200mm Long  
**AR6-436**



Self Retaining Retractor - Medium - 250mm Long  
**AR6-437**



info@arhmansurgicals.com



Mobile & Whatsapp : +92-334-8046177



**Arhman Surgical**  
Benefiting you is our Priority

## Hooks, Levers & Retractors

Self Retaining Retractor - Large - 300mm Long  
**AR6-438**

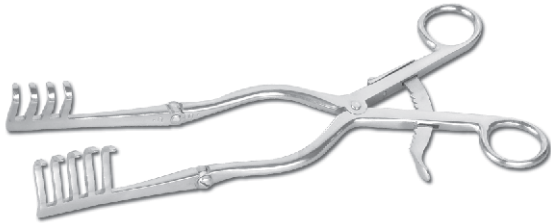

Self Retaining Retractor - Extra Large - 350mm Long  
**AR6-439**

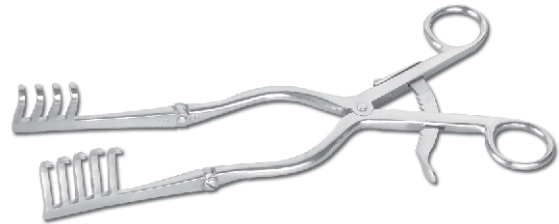

Gelpi Retractor - Small - 175mm  
**AR6-440**



Gelpi Retractor - Medium - 245mm  
**AR6-441**



Gelpi Retractor - Large - 315mm  
**AR6-442**



Periosteal Elevator - Straight

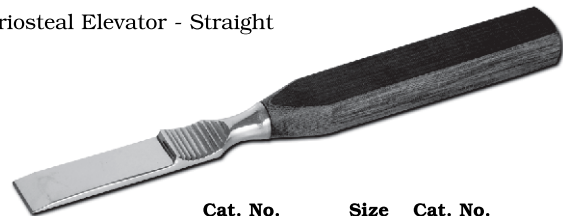

Cat. No.	Size	Cat. No.	Size
<b>AR6-443</b>	6mm	<b>AR6-447</b>	14mm
<b>AR6-444</b>	8mm	<b>AR6-448</b>	16mm
<b>AR6-445</b>	10mm	<b>AR6-449</b>	20mm
<b>AR6-446</b>	12mm	<b>AR6-450</b>	25mm

Periosteal Elevator - Curved

Cat. No.	Size	Cat. No.	Size
<b>AR6-451</b>	6mm	<b>AR6-455</b>	14mm
<b>AR6-452</b>	8mm	<b>AR6-456</b>	16mm
<b>AR6-453</b>	10mm	<b>AR6-457</b>	20mm
<b>AR6-454</b>	12mm	<b>AR6-458</b>	25mm



info@arhmansurgicals.com



Mobile & Whatsapp : +92-334-8046177



**Arhman Surgical**  
Benefiting you is our Priority

### Periosteal Elevator

Periosteal Elevator - 6.0mm Width, Straight Blade, Straight Edge  
**AR6-459**

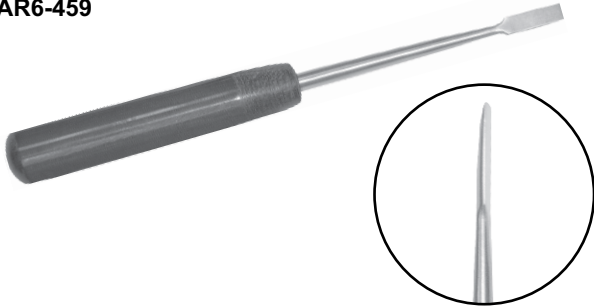

Periosteal Elevator - 13.0mm Width, Straight Blade, Straight Edge  
**AR6-460**

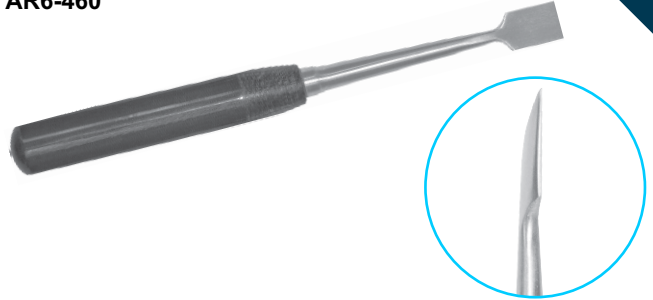

Periosteal Elevator - 14.0mm Width, Straight Blade, Round Edge  
**AR6-461**

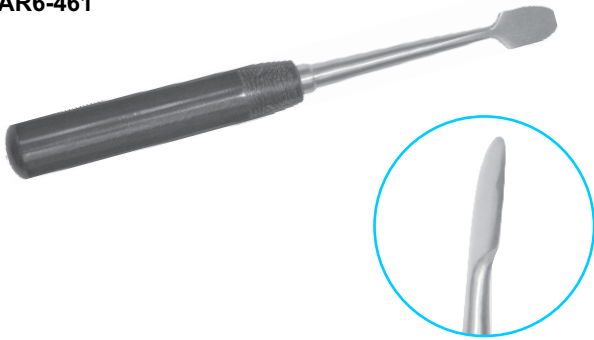

Periosteal Elevator - 3.0mm Width, Curved Blade, Straight Edge  
**AR6-462**

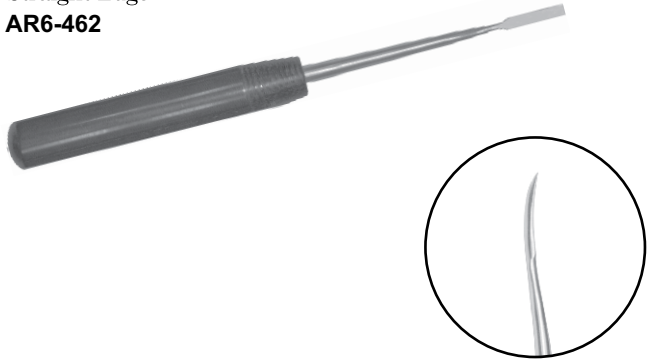

Periosteal Elevator - 6.0mm Width, Curved Blade, Straight Edge  
**AR6-463**

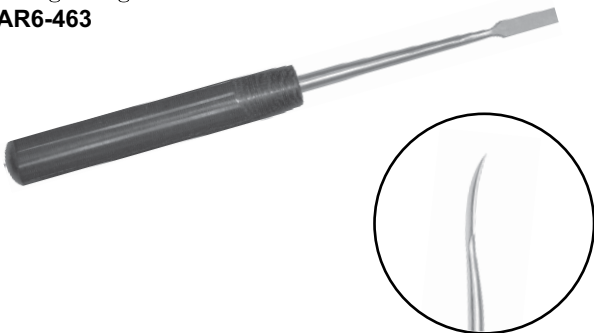

Periosteal Elevator - 6.0mm Width, Curved Blade, Round Edge  
**AR6-464**

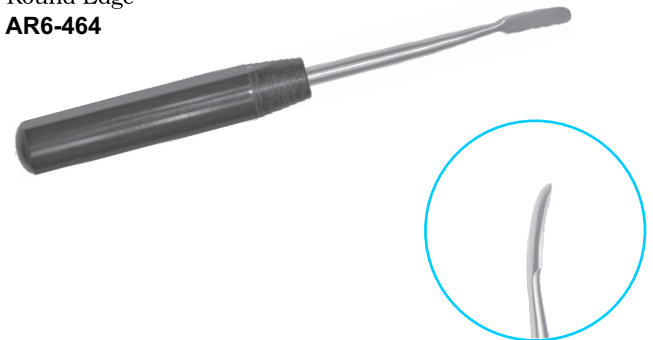

Periosteal Elevator - 13.0mm Width, Curved Blade, Straight Edge  
**AR6-465**



Periosteal Elevator - 14.0mm Width, Curved Blade, Round Edge  
**AR6-466**

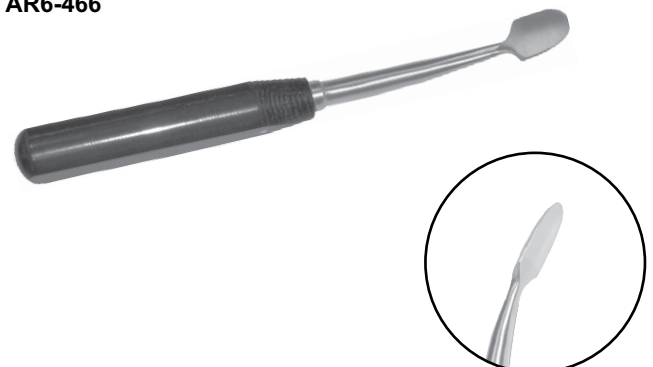



**Arhman Surgical**  
Benefiting you is our Priority

## Instruments For Kuntscher Nails

Bone Spreader

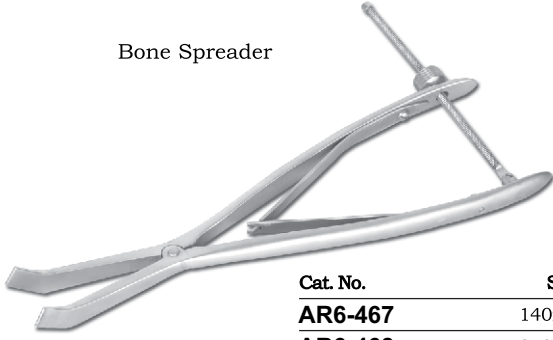

Cat. No.	Size
<b>AR6-467</b>	140mm
<b>AR6-468</b>	210mm
<b>AR6-469</b>	270mm

K. Nail Driver  
**AR6-470**



K. Nail Setting Device  
**AR6-471**



K. Nail Extractor with Two Hooks  
**AR6-472**

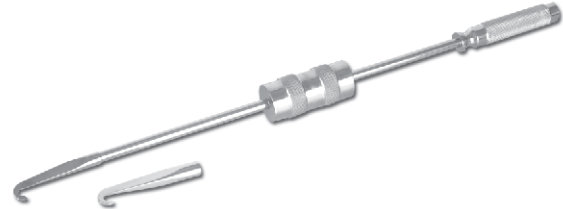

K. Nail Measuring Gauge  
**AR6-473**



Diamond Pointed Awl  
**AR6-474**



Guide Wire for K. Nail



Cat. No.	Size
<b>AR6-475</b>	2.5mm for 6 & 7mm Nails
<b>AR6-476</b>	3.0mm for 8 & 9mm Nails
<b>AR6-477</b>	4.0mm for 10 & 11mm Nails
<b>AR6-478</b>	4.5mm for 12 & 13mm Nails

K. Nail Reamer

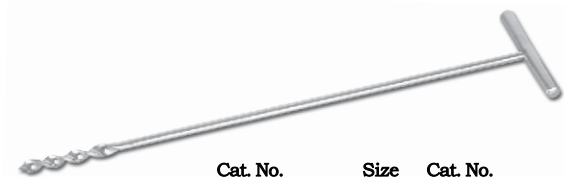

Cat. No.	Size	Cat. No.	Size
<b>AR6-479</b>	6mm	<b>AR6-484</b>	11mm
<b>AR6-480</b>	7mm	<b>AR6-485</b>	12mm
<b>AR6-481</b>	8mm	<b>AR6-486</b>	13mm
<b>AR6-482</b>	9mm	<b>AR6-487</b>	14mm
<b>AR6-483</b>	10mm		



info@arhmansurgicals.com



Mobile & Whatsapp : +92-334-8046177



**Arhman Surgical**  
Benefiting you is our Priority

## Instruments For Kuntscher Nails

Spare Hook for K. Nail Extractor  
**AR6-488**



Slide Hammer for K- Nail Extractor Set  
**AR6-489**

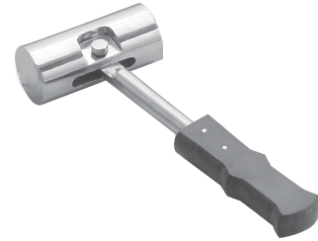

Locking Plier - Large  
**AR6-490**

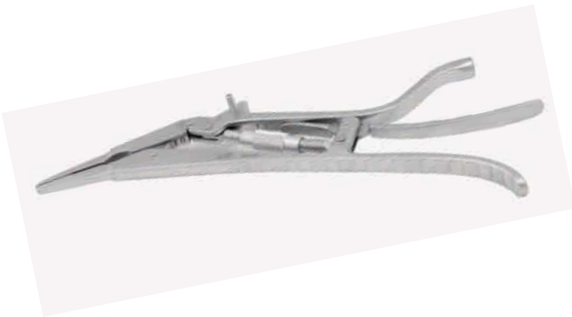

Extraction Rod with Hammer for Locking Plier  
**AR6-491**





**Arhman Surgical**  
Benefiting you is our Priority

## Instruments For Hip Prosthesis

Rasp for Austin Moore - Standard Stem  
**AR6-492**



Rasp for Austin Moore - Narrow Stem  
**AR6-493**



Rasp for Thompson - Standard Stem  
**AR6-494**



Rasp for Thompson - Narrow Stem  
**AR6-495**



Murphy Lane Bone Skid  
**AR6-496**



Moore Hollow Chisel  
**AR6-497**



Moore Hollow Chisel with Fibre Handle - Standard  
**AR6-498**



Moore Hollow Chisel with Fibre Handle - Extra Large  
**AR6-499**

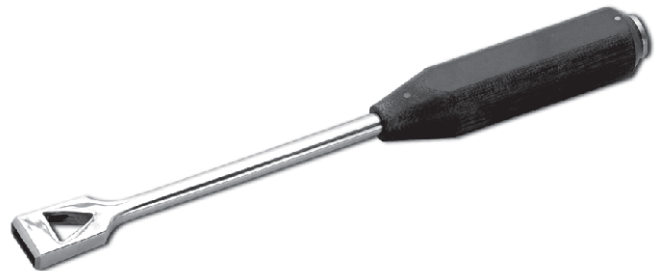





**Arhman Surgical**  
Benefiting you is our Priority

## Instruments For Hip Prosthesis

Judet Auger Extractor  
**AR6-500**



Measuring Gauge for Prosthesis



**Cat. No.**  
**AR6-501**  
**AR6-502**

**Size**  
Set of Ten (38 to 56mm)  
Set of Ten (37 to 55mm)

Impactor - Nylon Faced  
**AR6-504**



Impactor - Nylon Faced, Large Tip  
**AR6-503**



Extractor with Two Hooks  
**AR6-505**

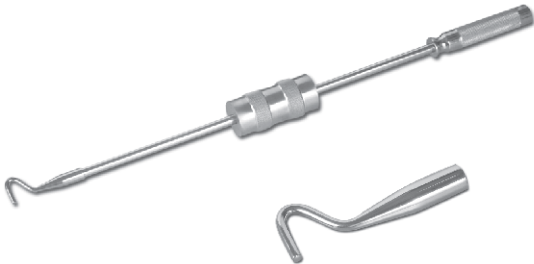

Spare Hook for Extractor  
**AR6-506**





**Arhman Surgical**  
Benefiting you is our Priority

## Instruments For Plaster Cutting

Plaster Saw Heavy Handle  
**AR6-507**



Plaster Saw Engel  
**AR6-508**



Plaster Saw Bergman  
**AR6-509**



Plaster Spreader  
**AR6-510**



Plaster Shear - Bohler's  
**AR6-511**



Plaster Shear - Stille's  
**AR6-512**



Plaster Shear - Gay's  
**AR6-513**



Bandage Cutting Scissor  
**AR6-514**



Plaster Bender  
**AR6-515**



Plaster Opener - Daw's  
**AR6-516**





**Arhman Surgical**  
Benefiting you is our Priority

Anchor Screw Driver  
**AR6-517**



Anchor Pointer

## Instruments For Anchor Screw

Anchor Guide Sleeve  
**AR6-518**



Suture Puller With Loop  
**AR6-519**



Cat No.	Size
<b>AR6-520</b>	3.0mm
<b>AR6-521</b>	5.0mm

## Instruments for Skull Surgery

Gigli Saw Wire 50cm long  
**AR6-522**



Gigli Saw Introducer  
**AR6-523**



Gigli Saw Handle - Pair  
**AR6-524**



## Cannulated Rigid Reamer



Cat. No.	Size	Cat. No.	Size
<b>AR6-525</b>	6.0mm	<b>AR6-533</b>	11.0mm
<b>AR6-526</b>	7.0mm	<b>AR6-534</b>	11.5mm
<b>AR6-527</b>	8.0mm	<b>AR6-535</b>	12.0mm
<b>AR6-528</b>	8.5mm	<b>AR6-536</b>	12.5mm
<b>AR6-529</b>	9.0mm	<b>AR6-537</b>	13.0mm
<b>AR6-530</b>	9.5mm	<b>AR6-538</b>	13.5mm
<b>AR6-531</b>	10.0mm	<b>AR6-539</b>	14.0mm
<b>AR6-532</b>	10.5mm		



info@arhmansurgical.com



Mobile & Whatsapp : +92-334-8046177



**Arhman Surgical**  
Benefiting you is our Priority

## Instruments For Interlocking Nail Removal

Extractor Rod  
**AR6-540**



Handle For Extractor  
**AR6-541**



Hammer For Extractor Rod  
**AR6-542**

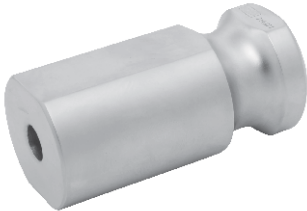

T-Wrench 10mm Cannulated  
**AR6-543**

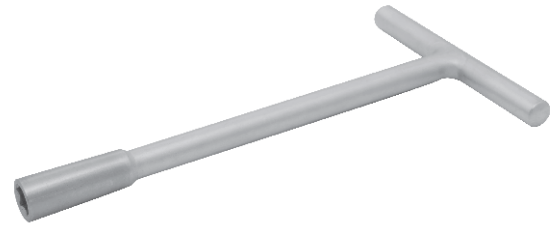

Conical Bolt

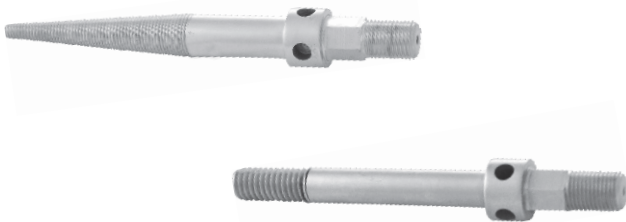

Conical Extraction Reamer (For Removal of I.L. Nails)  
**AR6-544**



Cat. No.	Size
<b>AR6-545</b>	20mm Tapped Thread TPI
<b>AR6-546</b>	22mm Tapped Thread TPI
<b>AR6-547</b>	24mm Tapped Thread TPI
<b>AR6-548</b>	26mm A Tapped Thread TPI
<b>AR6-549</b>	26mm B Tapped Thread TPI
<b>AR6-550</b>	16mm Straight Thread TPI

Cat. No.	Size
<b>AR6-551</b>	9,10,11mm Nails
<b>AR6-552</b>	12,13,14mm Nails





Arhman Surgical  
Benefiting you is our Priority

## Hand drills



Bone Surgery Martin hand drill

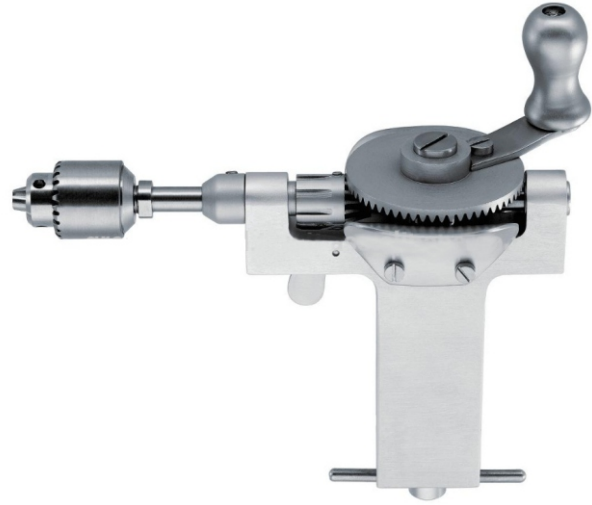

Bunnell Hand Drill



Moore Hand drill, complete with 2 drills

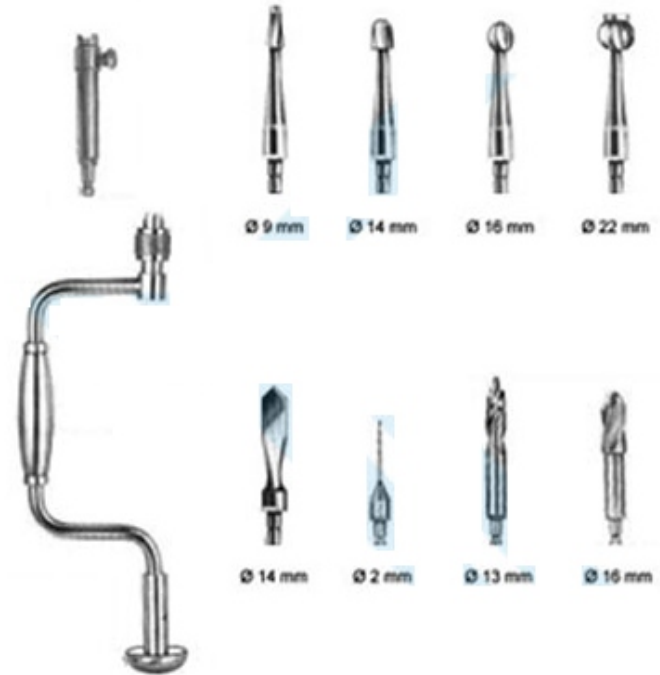

Hudson Hand drills





## Bone Curettes

Bone Curettes  
Scharfe Löffel  
Cucharillas cortantes  
Curettes tranchantes  
Curette taglienti

### Volkman Bone Curette

Oval

Catalog #	Size, Profile
OR-07-847	27.5 cm (10 3/4"), Fig. 4
OR-07-848	27.5 cm (10 3/4"), Fig. 0
OR-07-849	27.5 cm (10 3/4"), Fig. 1
OR-07-850	27.5 cm (10 3/4"), Fig. 2
OR-07-851	27.5 cm (10 3/4"), Fig. 3



### Schede Bone Curette

Oval

Catalog #	Size, Scoop Size, Profile
OR-07-852	17 cm (6 3/4"), 2.5 mm, Fig. 000
OR-07-853	17 cm (6 3/4"), 3.4 mm, Fig. 00
OR-07-854	17 cm (6 3/4"), 4.2 mm, Fig. 0
OR-07-855	17 cm (6 3/4"), 5.2 mm, Fig. 1
OR-07-856	17 cm (6 3/4"), 6.3 mm, Fig. 2
OR-07-857	17 cm (6 3/4"), 7.4 mm, Fig. 3
OR-07-858	17 cm (6 3/4"), 8 mm, Fig. 4



### Volkman Bone Curette

Oval

Catalog #	Size, Scoop Size, Profile
OR-07-859	17 cm (6 3/4"), 2.8 mm, Fig. 0000
OR-07-860	17 cm (6 3/4"), 3.6 mm, Fig. 000
OR-07-861	17 cm (6 3/4"), 4.4 mm, Fig. 00
OR-07-862	17 cm (6 3/4"), 5.2 mm, Fig. 0
OR-07-863	17 cm (6 3/4"), 6.8 mm, Fig. 1
OR-07-864	17 cm (6 3/4"), 8.5 mm, Fig. 2
OR-07-865	17 cm (6 3/4"), 10 mm, Fig. 3
OR-07-866	17 cm (6 3/4"), 11.5 mm, Fig. 4
OR-07-867	17 cm (6 3/4"), 13 mm, Fig. 5
OR-07-868	17 cm (6 3/4"), 14.5 mm, Fig. 6





## Wire Twisting Forceps

Wire Twisting Forceps  
Drahtwirbelzangen  
Pinzas para torcer alambre  
Pincers à torsader le fil  
Pinze per ritorcere fili

### TC Wire Twisting Forcep

Curved



Catalog #	Size
OR-07-478	14.5 cm (5 3/4")

### TC Corwin Wire Twisting Forcep



Catalog #	Size
OR-07-479	16 cm (6 1/4")

### TC Combi Wire Twisting Forcep

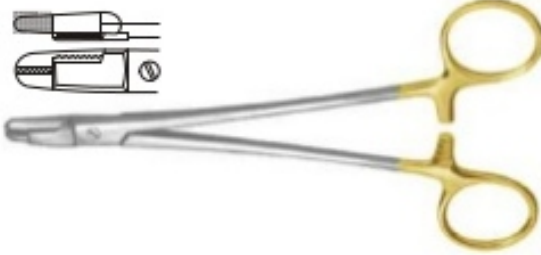

Catalog #	Size
OR-07-480	18.5 cm (7 1/4")

### TC Berry Wire Twisting Forcep

Heavy Pattern, With Tungsten Carbide Inserts

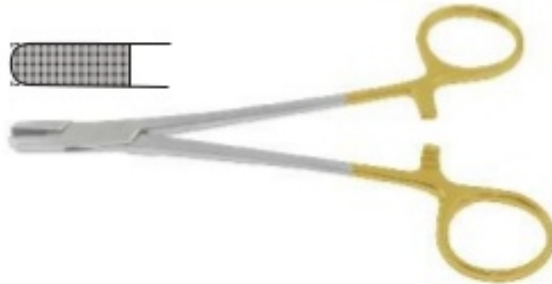

Catalog #	Size
OR-07-481	19 cm (7 1/2")

### Combi-Flat Nose Plier

Parallel Grip, Compound Action



Catalog #	Size
OR-07-482	18 cm (7")
OR-07-483	18 cm (7")
OR-07-484	18 cm (7")





## Flat Nose Plier

Flat Nose Pliers, Vise Grip, Combi-Flat Nose Plier  
Flachzangen, Tonnenzange, Kombinationszange, Flachzangen  
Alicates de pico plano, Alicates de pico plano, Combi-Alicat e de alambre  
Pincas plates, Pincas plates, Combi-Pince pour fils  
Tenaglie piatte, Tenaglie piatte, Combi-Pinza per fili

### Flat Nose Plier

Pointed



Catalog #	Size
OR-07-490	19.5 cm (7 3/4")

### Flat Nose Plier

With Longitudinal Groove



Catalog #	Size
OR-07-491	16 cm (6 1/4")

### Combi-Flat Nose Plier

For Bending and Cutting

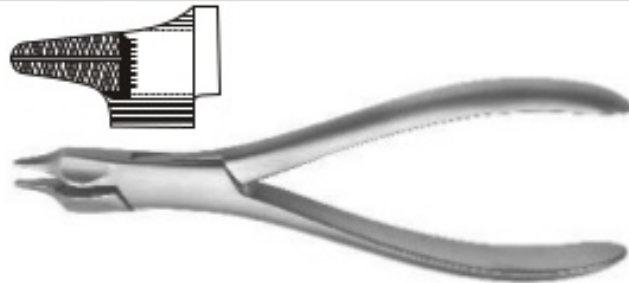

Catalog #	Size
OR-07-492	15 cm (6")

### Flat Nose Plier

Parallel Grip

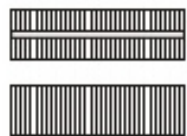

Catalog #	Size
OR-07-493	18.5 cm (7 1/4")

### Vise Grip Plier



Catalog #	Size
OR-07-494	20.5 cm (8")







Arhman Surgical  
Benefiting you is our Priority

## Flat Nose Plier

Flat Nose Pliers  
Flachzangen  
Alicates de picoplano  
Pinces plates  
Tenaglie piate

### Flat Nose Plier



Catalog #	Size
OR-07-485	13.5 cm (5 1/4")

### Flat Nose Plier



Catalog #	Size
OR-07-486	14 cm (5 1/4")

### Flat Nose Plier



Catalog #	Size
OR-07-487	14 cm (5 1/4")

### Flat Nose Plier



Catalog #	Size
OR-07-488	17.5 cm (7")

### Flat Nose Plier

With Crosswise Groove



Catalog #	Size
OR-07-489	17 cm (6 3/4")



info@arhmansurgicals.com



Mobile & Whatsapp : +92-334-8046177



## Strimmenn Tendon Holding Forceps

Tendon Holding Forceps, Tendon Tunnelling Forceps  
Sehnenfazzangen, Sehnedurchzugzangen  
Pinzas para coger tendones, Pinzas para pasar tendones  
Pinces pour saisir les tendons, Pinces pour passer les tendons  
Pinze per afferrare tendini, Pinze passa-tendini

### Steinmann Tendon Holding Forcep



Catalog #	Size
OR-08-274	15 cm (6")

### Brand Tendon Tunnelling Forcep

1 x 2 Teeth



Catalog #	Size
OR-08-275	19 cm (7 1/2")
OR-08-276	24 cm (9 3/4")
OR-08-277	21 cm (8 1/4")

### Tendon Tunnelling Forcep

1 x 2 Teeth



Catalog #	Size
OR-08-278	21 cm (8 1/4")

### Tendon Tunnelling Forcep

1 x 2 Teeth



Catalog #	Size
OR-08-279	21 cm (8 1/4")

### Carroll Tendon Tunnelling Forcep



Catalog #	Size
OR-08-280	11.5 cm (4 1/2")





## Bone Holding Forceps

Bone Holding Forceps  
Knochenhaltezaugen  
Pinzas para hueso  
Daviers porte-os  
Tenaglie per ossa

### Bone Holding Forcep

Self Centering, With Thread Fixation

Catalog #	Size
OR-08-329	15 cm (6")
OR-08-330	19 cm (7 1/2")
OR-08-331	24 cm (9 1/2")
OR-08-332	26 cm (10 1/4")
OR-08-333	28 cm (11")



### Lane Bone Holding Forcep

Without Ratchet

Catalog #	Size
OR-08-334	33 cm (13")



### Lane Bone Holding Forcep

With Ratchet

Catalog #	Size
OR-08-335	33 cm (13")



### Verbrugge Bone Holding Forcep

Catalog #	Size
OR-08-336	25 cm (9 3/4")
OR-08-337	26 cm (10 1/4")
OR-08-338	27 cm (10 3/4")

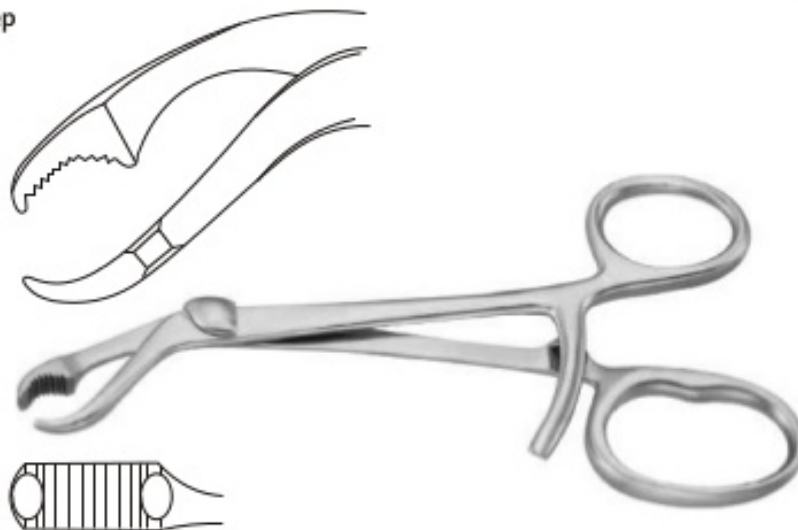



## Aluminum Hands

Hand Restrainer, Tourniquet, Finger Nail Drill  
Handhalter, Kompressorium, Fingernagelbohrer  
Sujetador de mano, Compresor, Dedo clavo perforación  
Reteneur pour main, Compresseur, Foret d'angle de doigt  
Fissatore per mano, compressorio, Dito trivello del chiodo

### Aluminium Hand

Catalog #	Size, Profile
OR-08-409	N/A, For Children
OR-08-410	N/A, For Adults



### Feldheim Tourniquet

Catalog #	Size
OR-08-411	10 cm (4")



### Ideal Finger Nail Drill Complete

With Drill Ref: OR-992-01 to OR-992-03

Catalog #	Size
OR-08-412	N/A



### Spare Drill

Catalog #	Size, Profile
OR-08-413	N/A, Small
OR-08-414	N/A, Medium
OR-08-415	N/A, Large



### Martin Finger Ring Saw

Catalog #	Size
OR-08-416	18.5 cm (7 1/4")





Arhman Surgical  
Benefiting you is our Priority

## Nail Fixation Orthopedic

# ADVANCED NAIL DESIGN

The nail design offers great flexibility

- One system for retrograde and antegrade technique
- One system for left and right femur
- Anatomic bend for ease in insertion and extraction
- Cannulation of all nails for guided insertion in reamed and unreamed technique
- Large portfolio with nail diameters ranging from  $\varnothing$  9.0 to 15.0 mm and lengths ranging from 160 to 480 mm
- Versatile locking configuration for static, dynamic, standard and spiral blade locking



**retrograde**  
RFN, 160–200 mm  
straight



**retrograde**  
RFN, 220–280 mm  
antecurvature 1500 mm



**retrograde**  
R/AFN, 300–480 mm  
antecurvature 1500 mm

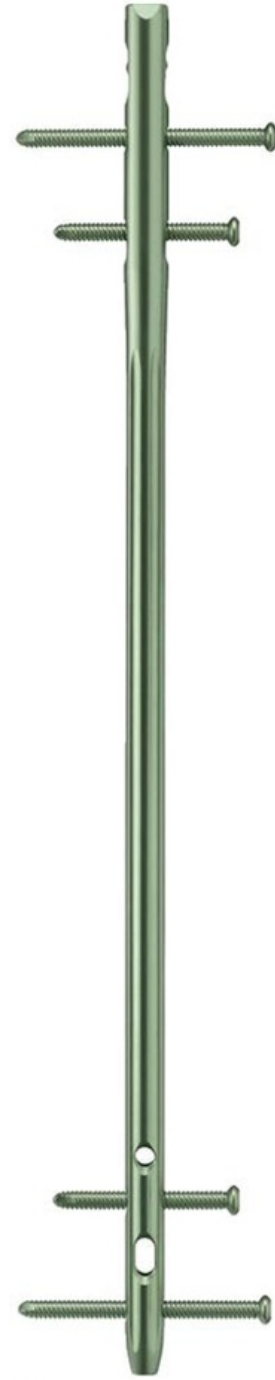

**antegrade**  
R/AFN, 300–480 mm  
antecurvature 1500 mm





**Arhman Surgical**  
Benefiting you is our Priority

## Tibia Plates

### 3.5 MM LCP MEDIAL DISTAL TIBIA PLATE (WITH TAB) - RIGHT & LEFT

REFERENCE NO. (Stainless Steel)	REFERENCE NO. (Titanium)	SIZE-RIGHT
1308-SS-3504	1308-TT-3504	4 HOLES
1308-SS-3506	1308-TT-3506	6 HOLES
1308-SS-3508	1308-TT-3508	8 HOLES
1308-SS-3510	1308-TT-3510	10 HOLES
1308-SS-3512	1308-TT-3512	12 HOLES
1308-SS-3514	1308-TT-3514	14 HOLES



REFERENCE NO. (Stainless Steel)	REFERENCE NO. (Titanium)	SIZE-LEFT
1309-SS-3504	1309-TT-3504	4 HOLES
1309-SS-3506	1309-TT-3506	6 HOLES
1309-SS-3508	1309-TT-3508	8 HOLES
1309-SS-3510	1309-TT-3510	10 HOLES
1309-SS-3512	1309-TT-3512	12 HOLES
1309-SS-3514	1309-TT-3514	14 HOLES

### 3.5 / 5 MM LCP METAPHYSEAL PLATE



REFERENCE NO. (Stainless Steel)	REFERENCE NO. (Titanium)	SIZE
1328-SS-3508	1328-TT-3508	5+3 HOLES
1328-SS-3509	1328-TT-3509	5+4 HOLES
1328-SS-3510	1328-TT-3510	5+5 HOLES
1328-SS-3511	1328-TT-3511	5+6 HOLES
1328-SS-3512	1328-TT-3512	5+7 HOLES
1328-SS-3513	1328-TT-3513	5+8 HOLES
1328-SS-3514	1328-TT-3514	5+9 HOLES
1328-SS-3516	1328-TT-3516	5+11 HOLES
1328-SS-3518	1328-TT-3518	5+13 HOLES





**Arhman Surgical**  
Benefiting you is our Priority

## Tibia Plates

### 2.4 MM / 2.7 MM VA - TWO COLUMN VOLAR DISTAL RADIUS PLATE - RIGHT & LEFT

REFERENCE NO. (Stainless Steel)	REFERENCE NO. (Titanium)	SIZE-RIGHT
1373-SS-2702	1373-TT-2702	2 HOLES
1373-SS-2703	1373-TT-2703	3 HOLES
1373-SS-2704	1373-TT-2704	4 HOLES
1373-SS-2705	1373-TT-2705	5 HOLES

REFERENCE NO. (Stainless Steel)	REFERENCE NO. (Titanium)	SIZE-LEFT
1374-SS-2702	1374-TT-2702	2 HOLES
1374-SS-2703	1374-TT-2703	3 HOLES
1374-SS-2704	1374-TT-2704	4 HOLES
1374-SS-2705	1374-TT-2705	5 HOLES



### 5.0 MM LCP DISTAL FEMUR PLATE - RIGHT & LEFT

REFERENCE NO. (Stainless Steel)	REFERENCE NO. (Titanium)	SIZE-RIGHT
1319-SS-5005	1319-TT-5005	5 HOLES
1319-SS-5007	1319-TT-5007	7 HOLES
1319-SS-5009	1319-TT-5009	9 HOLES
1319-SS-5011	1319-TT-5011	11 HOLES
1319-SS-5013	1319-TT-5013	13 HOLES
1319-SS-5015	1319-TT-5015	15 HOLES



REFERENCE NO. (Stainless Steel)	REFERENCE NO. (Titanium)	SIZE-LEFT
1320-SS-5005	1320-TT-5005	5 HOLES
1320-SS-5007	1320-TT-5007	7 HOLES
1320-SS-5009	1320-TT-5009	9 HOLES
1320-SS-5011	1320-TT-5011	11 HOLES
1320-SS-5013	1320-TT-5013	13 HOLES
1320-SS-5015	1320-TT-5015	15 HOLES





## Arhman Surgical

Benefiting you is our Priority



Address:  
Small Industrial State Sialkot 51310, Pakistan.



Mobile & Whatsapp : +923348046177



E-Mail: [info@arhmansurgicals.com](mailto:info@arhmansurgicals.com)



website: [www.arhmansurgicals.com](http://www.arhmansurgicals.com)



Rehman hussain



Rehman Hussain



[arhmansurgical@gmail.com](mailto:arhmansurgical@gmail.com)



[info@arhmansurgicals.com](mailto:info@arhmansurgicals.com)



Mobile & Whatsapp : +92-334-8046177